

# Toolbox

## Materials Needed

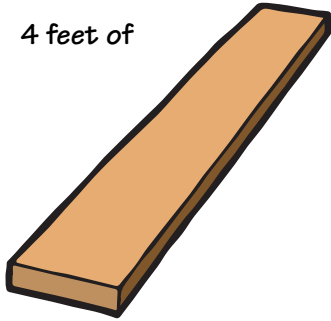

4 feet of



1 by 4 board  
( $\frac{3}{4}$  x  $3\frac{1}{2}$  x 48)

3 feet of

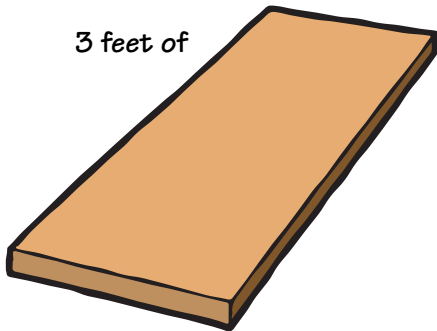

1 by 8 board  
( $\frac{3}{4}$  x  $7\frac{1}{4}$  x 36)

22 x

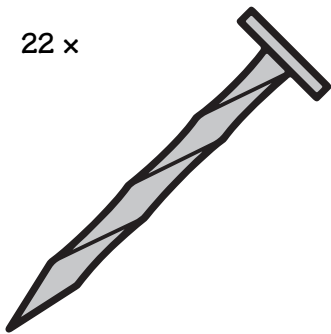

$\frac{1}{4}$ " spiral nails

18" of

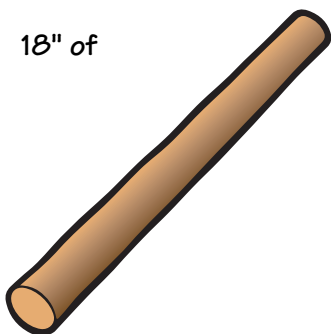

$\varnothing$  1" hardwood dowel

## Tools Needed

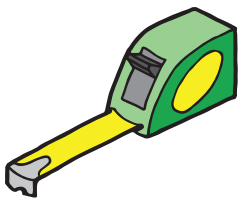

Tape Measure

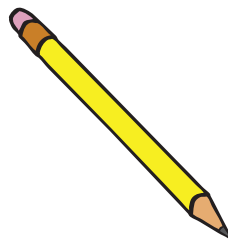

Pencil

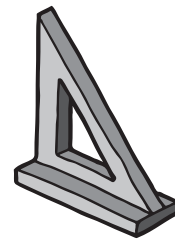

Speed Square



C-Clamp



Workbench



Handsaw



Safety Goggles



Drill

**Idea:** Use a branch to make a handle for a gardening tool box.

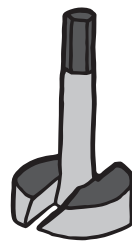

1" Forstner Bit

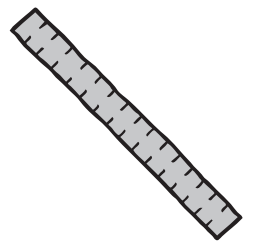

Rule

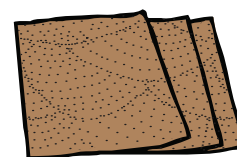

Sandpaper

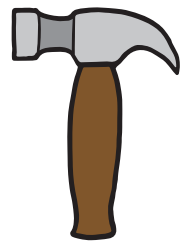

Hammer

# Toolbox

## Making the parts

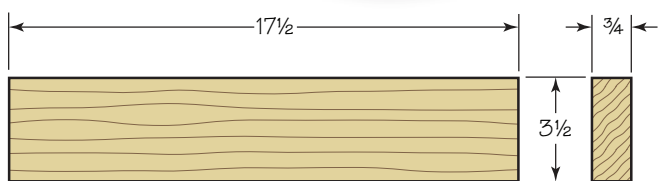
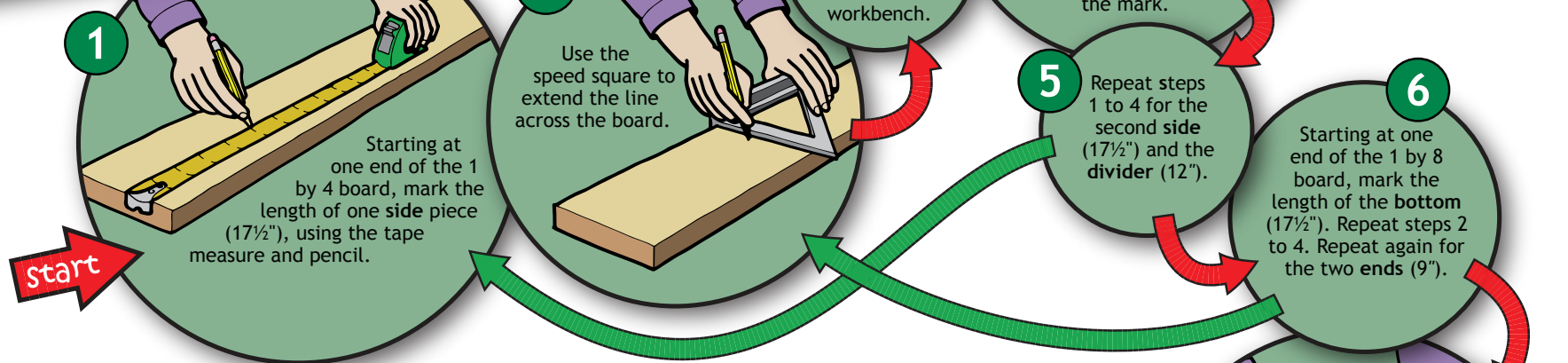

All measurements are in inches.

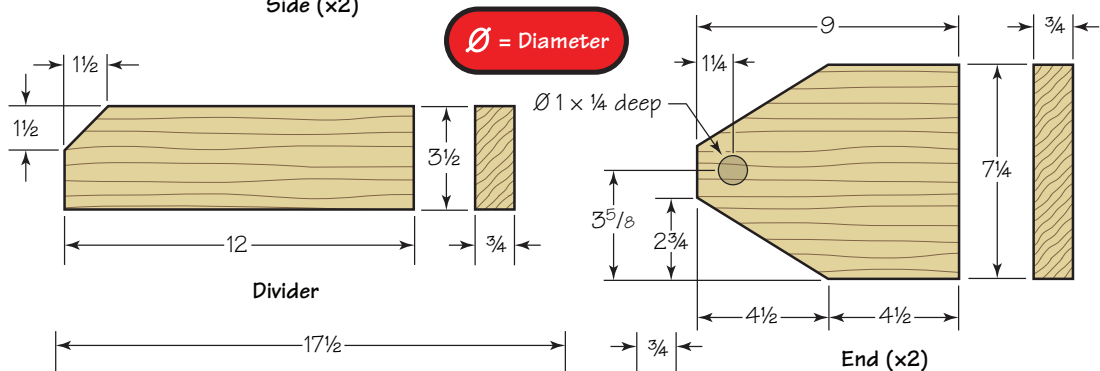

**Important:** Be careful not to drill the hole all the way through.

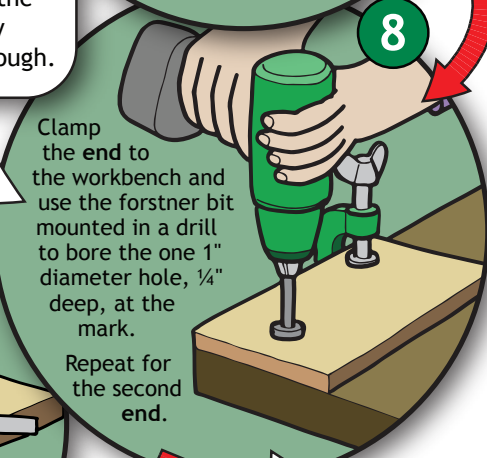
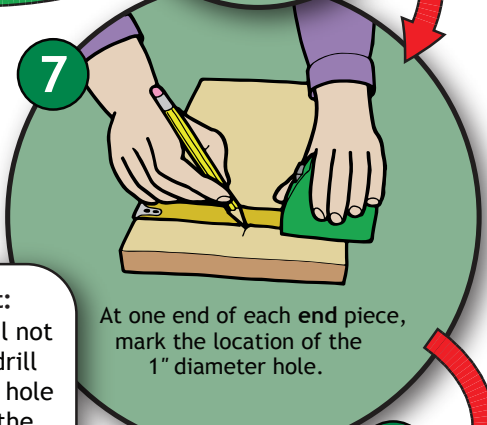

**Remember:** Wear your safety goggles when using a drill.

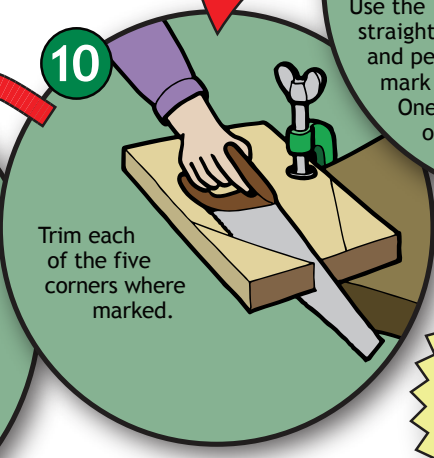
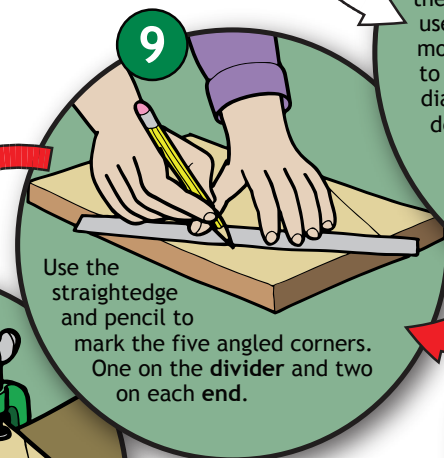
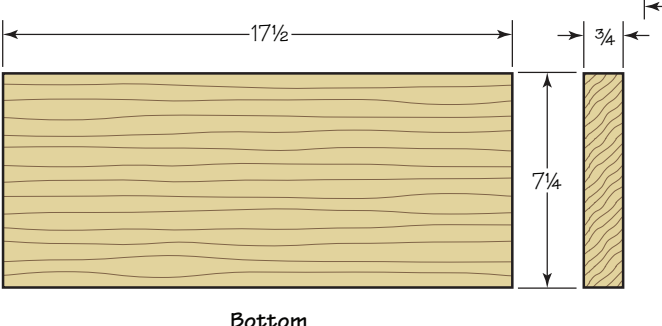

Congratulations you've made a toolbox

## assembly

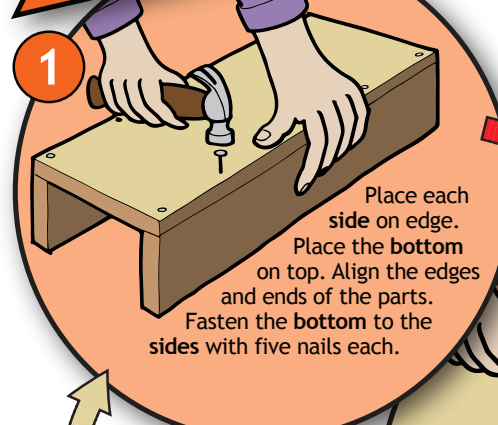

**Note:** Each nail is placed 3/8" in from the edge of the board.

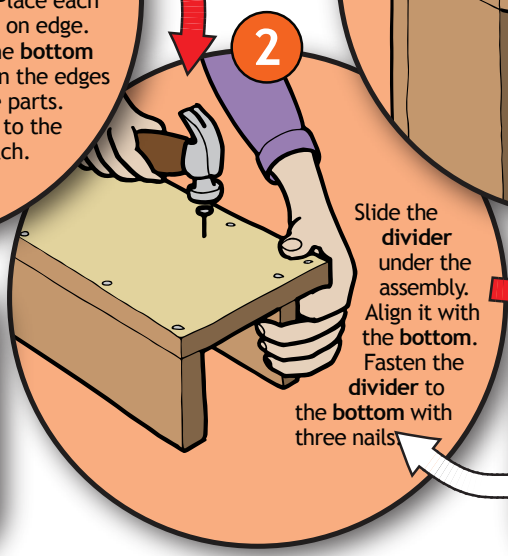

**Tip:** The divider can be located wherever you want. To use it to hold your saw, it should be 3/4" from one of the sides.

